

User Guide – ActiveCore Freezer

Thank you for purchasing a SKOPE refrigeration product.

Safety

Always observe safety precautions when using any electrical appliance. Read these instructions carefully and retain them for future reference.

WARNING

- Ensure the appliance is disconnected from the power supply before performing any cleaning or maintenance.
- Do not cover the grilles or block the entry or exhaust of airflow by placing objects up against the refrigeration unit.
- Should manual defrosting be necessary, turn off the refrigeration system and allow the ice to melt by air circulation. Collect ice and water during defrost to prevent a slip hazard. Do not use mechanical methods to remove ice, as this may damage the refrigeration circuit.
- Do not use any electrical devices or appliances inside the food storage compartment.

- This appliance is not intended for use by persons (including children) with reduced physical, sensory or mental capabilities, or lack of experience and knowledge, unless they have been given supervision or instruction concerning use of the appliance by a person responsible for their safety. Children should be supervised to ensure that they do not play with the appliance.
- Do not use this appliance for other than its intended use.
- Do not insert fingers/foreign objects into any holes.
- Only use this appliance with the voltage specified on the cabinet rating label.
- Ensure the appliance has adequate ventilation as this is essential to economical, high performance.
- Be careful not to touch moving parts and hot surfaces.
- For your own safety and that of others, ensure that all electrical work is done by authorised personnel.
- If the power supply flexible cord becomes damaged, it must be replaced by an authorised service agent or similarly qualified person in order to avoid a hazard.
- If installing or removing the refrigeration unit, refer to the Installation Guidelines below, and observe all necessary safety precautions.
- The appliance is not designed to be stable while in motion. Use extreme caution when moving or transporting it.
- Do not store explosive substances such as aerosol cans with a flammable propellant in this appliance.
- If the cabinet is to be scrapped, ensure the cabinet is unplugged from the power supply and cut off the mains flex close to the back of the cabinet. Be mindful of the risk of animals or children becoming trapped in the appliance – either remove or secure doors if necessary.
- Refrigerant must be removed by a qualified service person and the cabinet recycled/disposed of in accordance with local regulations.

WARNING

- Ensure the doors are held shut when moving or transporting the freezer.

This cabinet is designed to operate within a specific climatic class environment. See the cabinet rating label inside the cabinet for climate class number.

Climate class	Ambient temperature	Relative humidity
3	25°C	60%
4	30°C	55%
5	40°C	40%
7 (tropical)	35°C	75%

The cabinet includes relevant hazard symbols that may be associated with the freezer. Refer to the information below for symbol description.



WARNING

The refrigeration system contains flammable R290 refrigerant. Do not tamper with it. The refrigeration system must only be serviced by qualified personnel.

Service & Support

We know you will get years of satisfaction from your new SKOPE product when you follow a few simple preventative maintenance guidelines. Helpful information is available on the SKOPE website.

www.skope.com/serviceandsupport

Installation Guidelines

Ensure you consider and meet the installation guidelines.

If refrigeration cartridges must be removed (e.g. to transport the cabinet through a low clearance doorway), refer to the Unit Removal Instructions on the back of the cabinet. Contact SKOPE if they are missing.

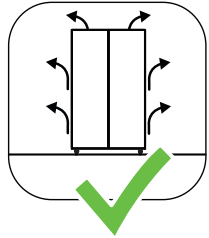

Ventilation

Ensure all ventilation requirements below are met.

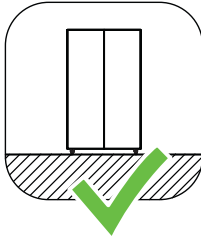

Surface

The installation surface must be capable of supporting the loaded cabinet.

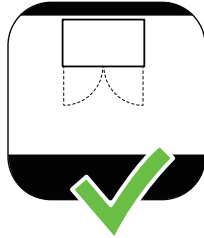

Door Opening

Allow adequate space for the door/s to open and close properly.

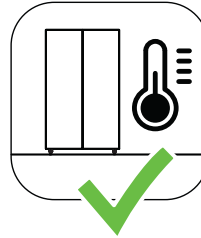

Climate Class

The freezer must be installed in an environment within its climate class.

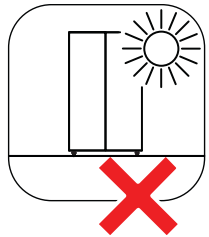
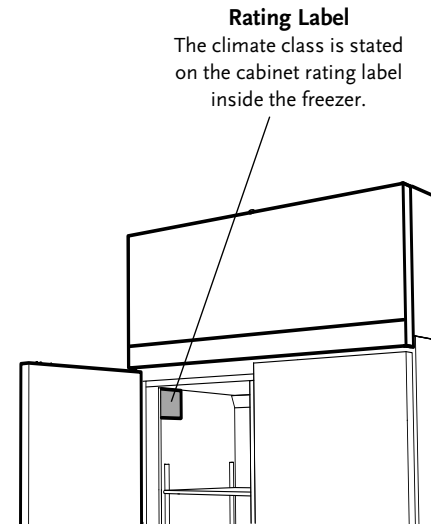

Sunlight

Do not install the freezer in direct sunlight.

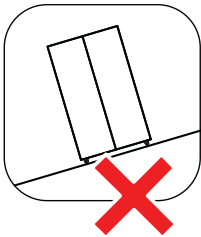

Uneven Surface

Do not install the freezer on an uneven surface.

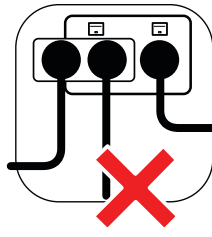

Power Supply

Do not overload the power supply.

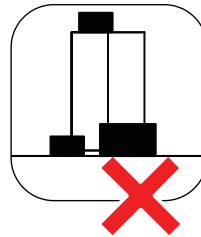

Blocking Ventilation

Do not store boxes or items in front or on top of the freezer.

Ventilation Requirements

This freezer must have the following ventilation clearances at all times.

In certain climatic conditions, condensation may form on the back of the cabinet. If this is observed, ensure air circulation between cabinet and wall by adhering two of the enclosed self-adhesive blocks to the cabinet back as shown.

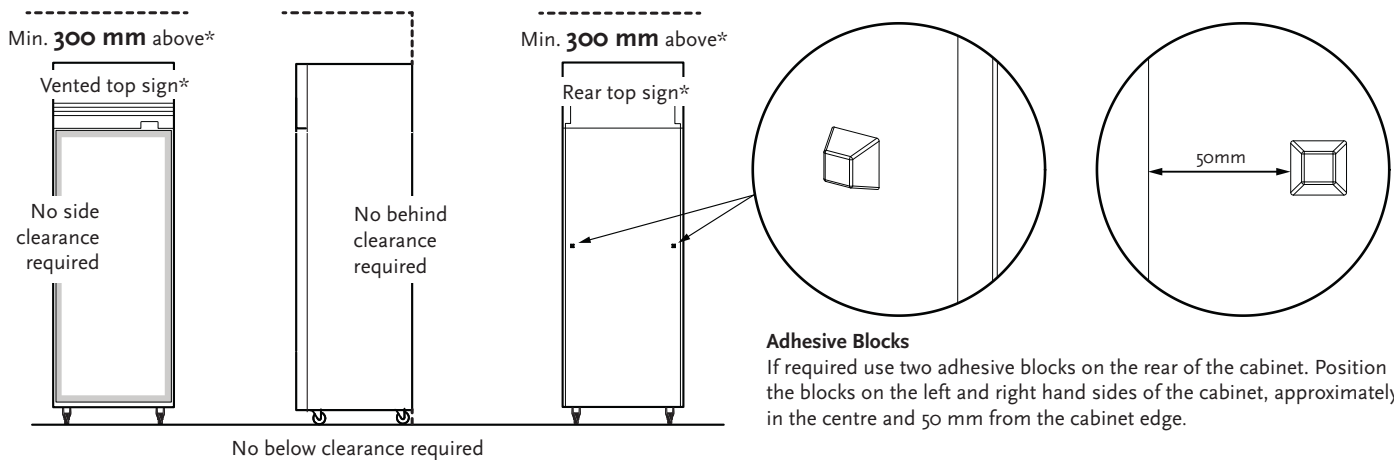

Door Handles

The door handles may be packed inside the cabinet.

To fit a door handle

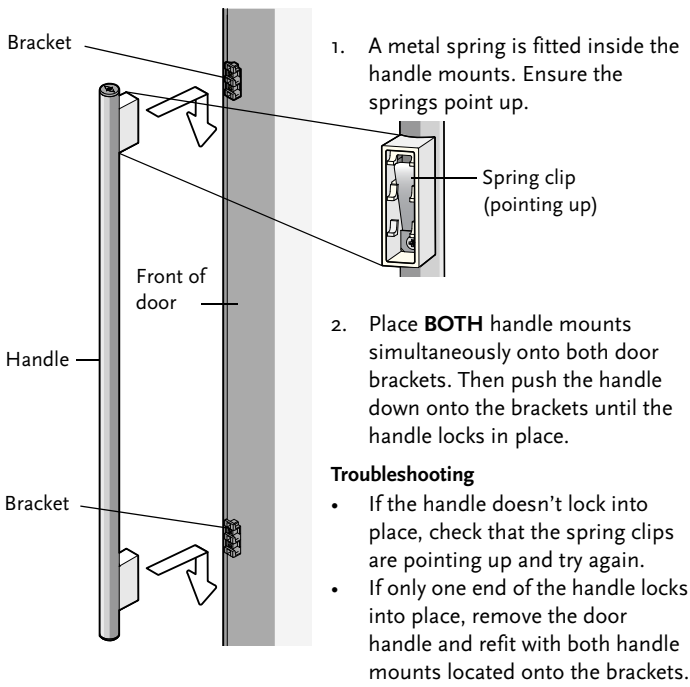

1. A metal spring is fitted inside the handle mounts. Ensure the springs point up.
2. Place **BOTH** handle mounts simultaneously onto both door brackets. Then push the handle down onto the brackets until the handle locks in place.

Troubleshooting

- If the handle doesn't lock into place, check that the spring clips are pointing up and try again.
- If only one end of the handle locks into place, remove the door handle and refit with both handle mounts located onto the brackets.

To remove a door handle

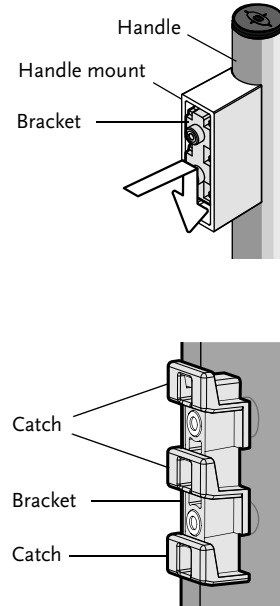

1. Peel back the door gasket from behind the handle mounts on the inside of the door frame.
2. Unscrew the handle mounts through the holes on the inside of the door frame, and remove the handle.
3. Only unscrew the top and bottom screws. Do **NOT** unscrew the middle screw.
4. Remove the bracket/s from the handle mount by pressing the bracket in and down until it unclips from the handle mount.
5. Fit and screw the bracket/s back onto the door. Ensure the catches are pointing up as pictured.
6. Clip the gasket back into place on the inside of the door frame. If the gasket is out of shape, use a hair drier to heat and reshape it.

Shelves

The wire shelves sit on shelf clips which twist onto the shelf support strips inside the cabinet. The shelves may be positioned at different heights to suit various product. Use the numbers on the shelf support strips to help set the shelf clips at the same height.

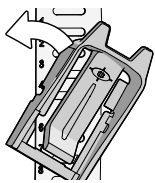

To fit a shelf clip
Twist anticlockwise onto the shelf support strip.

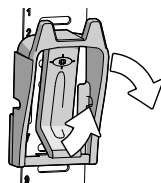

To remove a shelf clip
Pull the centre tab up and twist off clockwise.

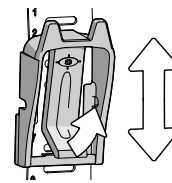

To adjust the shelf clip height
Pull the centre tab up, and slide up or down as required. Once in position, ensure it clicks into place.

Loading Product

Let the freezer run for 30 minutes before loading it with product for the first time. When loading the shelves with product:

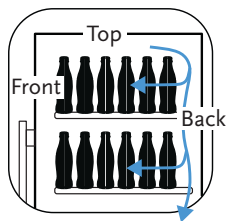

Internal Airflow

Leave 25 mm space between product and the back of cabinet interior.

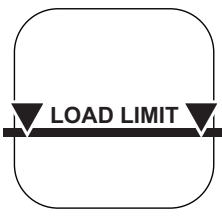

Load Limit

Do not load product above the load limit indicators on the cabinet interior sides.



Shelf Loading

Do not overload the shelves.



Shelf Flexing

Remove product if the shelf is flexing.



Shelf Overhang

Do not let product overhang the shelves.



Cabinet Floor

Do not load product on the cabinet floor. Use the shelves.

Door Lock/s

The cabinet may be fitted with bracket locks or key locks, located above or below each door. Bracket locks require a lock (padlock or similar) through the brackets to lock the door. Key locks can be locked with the supplied key.

Electronic Controller

The electronic controller regulates the cabinet's temperature, signals alarms and captures operational information. The temperature is factory-set for storing perishable product (all shelves maintain L1 temperature range: less than -18°C (can spike up to -15°C).

To customise the settings to your requirements and view historical data, download the SKOPE-connect app from the Google Play Store or Apple App Store, and connect via Bluetooth®.



Apple App
store



Google Play
store

Lights

The lights switch on and off automatically, depending on cabinet use.

Cleaning

Note: the TMF1500N and SKFT1500N cabinets have two refrigeration cartridges.

Ensure the cabinet is unplugged from the power supply before cleaning.

Wipe the inside and outside of the cabinet with a damp cloth, taking care to keep moisture away from electrical parts.

The condenser coil must be kept clean. SKOPE strongly urges cleaning the condenser coil every three months.

Do **NOT** use hard or sharp tools to clean the coil as these may cause damage.

Clean the Coil

1. Unplug the cabinet from the power supply, and unplug any lit sign panels.

2. Remove the front panel from the top of the cabinet.

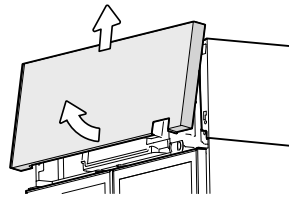

WARNING: Front panel is heavy, a two person lift is recommended.

3. Brush the condenser coil with a soft brush to remove any dust and fluff.

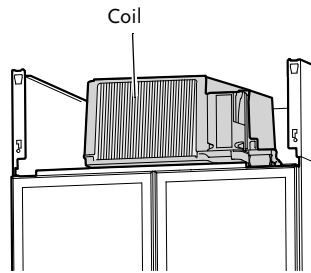

4. Refit the sign assembly and reconnect to the power supply.

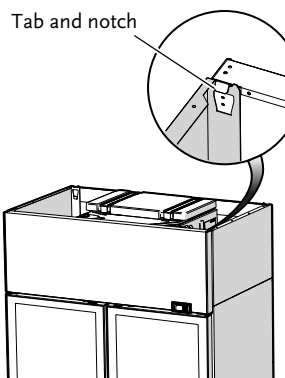

Important

When refitting, ensure the tabs on the back of the sign are located in the notches on top of the cabinet, and that the sign is pushed fully in and secure.